



NEON HORIZONTAL BEND

LED STRIP LIGHT 3W/FT

PROJECT:

PREPARED BY:

DATE:

TYPE:

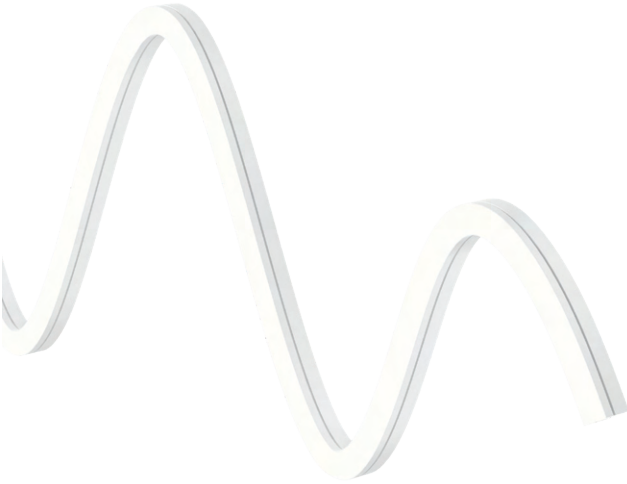

3W/FT

Neon

The Neon Horizontal Bend LED Strip is a flexible, IP67-rated lighting solution designed for smooth, side-bending installations. Built with high-efficacy 2835 SMD chips, it delivers up to 335 lumens per foot with a CRI of 90+, ideal for outlining curves, coves, and architectural edges with a soft, uniform glow. Its fully encapsulated body ensures durability in indoor and outdoor environments, while factory-sealed custom cuts and multiple cable outlet directions support tailored project needs



Ambient Lighting

Ideal for ambient lighting applications, this solution delivers a soft yet effective glow—perfect for cove details, ceiling integrations, and layered architectural compositions

PERFORMANCE

• Wattage	3W/FT	• Maximum Run	16.4FT
• Input Power	24V	• Certification	UL
• CRI	90+	• Dimming	Triac
• LED Chip	Neon	• Warranty	5 years

DIMENSIONS

• Length per Roll	16.4FT
• Height x Width	0.39" x 0.39"

INSTALLATION

• Environment	IP67	• Adhesive	3M
• Cutting Interval	3.93"	• Ambient Temperature	-20°C to 40°C

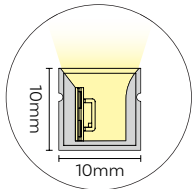



NEON HORIZONTAL BEND

LED STRIP LIGHT 3W/FT

PROJECT:

PREPARED BY:

DATE:

TYPE:

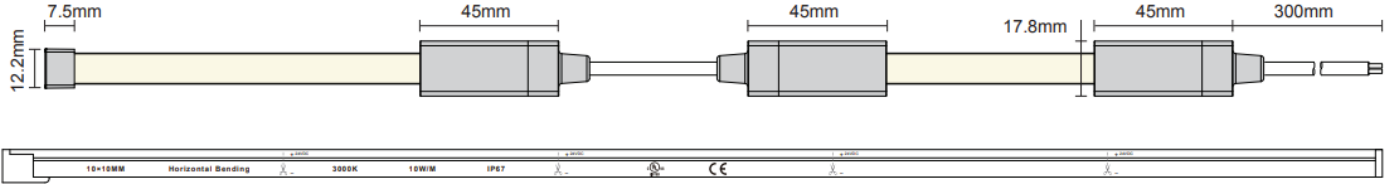

ORDER GUIDE

Model	Length (ft)	Wattage	CCT	Lumens/FT	Efficacy	IP Rating
LB53529	16.4FT	3W/FT	2700K	308LM	101LM/W	IP67
LB53530	16.4FT	3W/FT	3000K	320LM	105LM/W	IP67
LB53531	16.4FT	3W/FT	3500K	326LM	107LM/W	IP67
LB53532	16.4FT	3W/FT	4000K	335LM	110LM/W	IP67

- All cuts must be made directly on line indication
- Any cuts made in field must be properly sealed in order to be IP67 rated

NEON HORIZONTAL BEND

LED STRIP LIGHT 3W/FT

PROJECT:

PREPARED BY:

DATE:

TYPE:

DIMENSION AND OUTLET DIRECTION

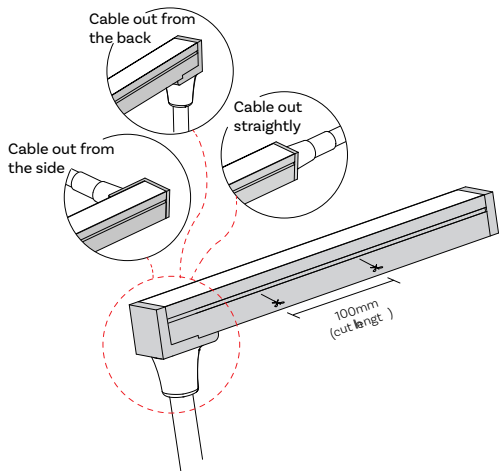
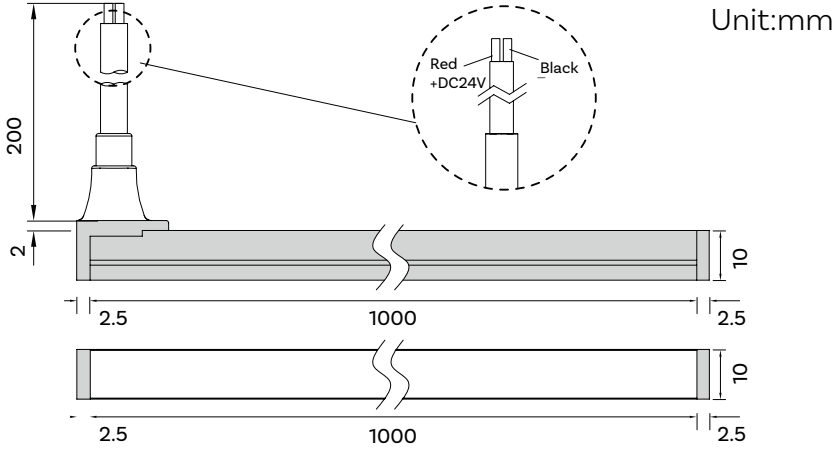

NEON HORIZONTAL BEND

LED STRIP LIGHT 3W/FT

PROJECT:

PREPARED BY:

DATE:

TYPE:

CONNECTING ACCESSORIES

LB53537 - Clear End Cap



LB53536 - Coupling

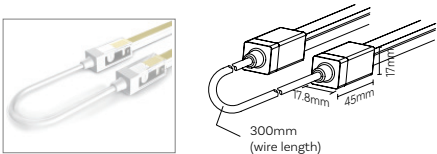

LB53540 - End Straight

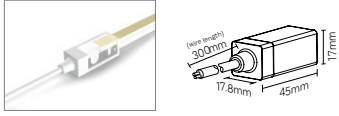

LB53541 - End side left

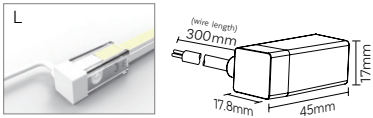

LB53542 - End side right

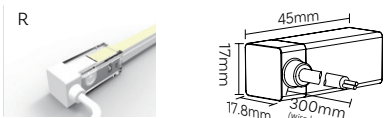

LB53543 - End bottom

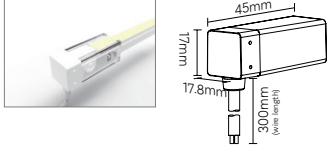

LB53539 - Aluminum Buckle

12mm x 12.5mm x 25mm

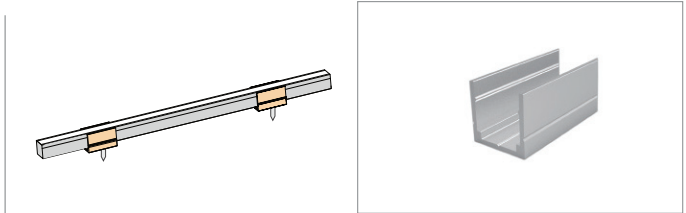
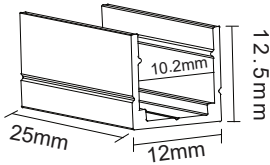

LB53538 - Aluminum Profile

12mm x 12.5mm x 2440mm

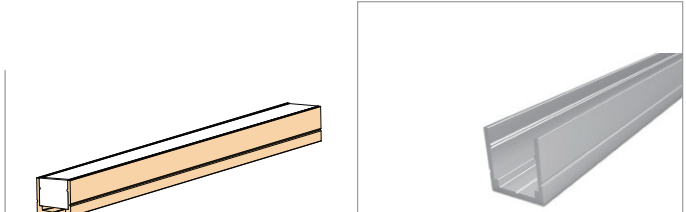
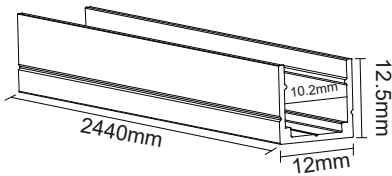



NEON HORIZONTAL BEND

LED STRIP LIGHT 3W/FT

PROJECT:

PREPARED BY:

DATE:

TYPE:

COMPATIBLE DRIVER



Model	LB55500
Wattage	120W
Dimensions	7.74" x 4.07" x 1.57"
Temperature	IP67
Dimming	Triac/MLV/ELV



Model	LB55461
Wattage	30W
Dimensions	4.97" x 3.15" x 1.59"
Temperature	IP67
Dimming	Triac/MLV/ELV



Model	LB55501
Wattage	200W
Dimensions	8.17" x 4.57" x 1.57"
Temperature	IP67
Dimming	Triac/MLV/ELV



Model	LB55463
Wattage	60W
Dimensions	4.97" x 3.15" x 1.59"
Temperature	IP67
Dimming	Triac/MLV/ELV



Model	LB55502
Wattage	300W
Dimensions	9.13" x 4.57" x 1.57"
Temperature	IP67
Dimming	Triac/MLV/ELV



Model	LB55465
Wattage	96W
Dimensions	4.97" x 3.15" x 1.59"
Temperature	IP67
Dimming	Triac/MLV/ELV