

PREPARED BY:  
PROJECT:  
TYPE:



# ULTRA-PRO 5 CHANNEL DMX512 & RDM DECODER CONTROLLER SERIES



## FEATURES

- Industrial level DMX512 & RDM decoder
- Comply with the latest DMX512, DMX512(1990), DMX512-A, RDM V1.0 (E1.20 - 2006 ESTA Standard) standard protocols, compatible with DMX512 master consoles from other international incorporations
- Total 5 PWM output channels, common anode. DMX channel quantity from 1CH to 5CH settable
- 8A 5 channels constant voltage output
- Abundant DMX signal input and output port design: XLR 5pin, XLR 3pin, RJ45, Screw DMX
- Enable DMX512 master console to detect decoder, display decoder information and set DMX address
- RDM bi-directional communication function
- Visible numeric digital display operation interface with a variety of features selection
- PWM output high frequency 16bit and low frequency 8bit switchable, default setting is 16bit
- 10 levels of PWM output frequency optional from 500Hz-30kHz, default setting is 1kHz
- Decoding modes optional, enable to adjust brightness of each channel, master brightness of all channels and strobe effects, default mode is dp1.1
- Gamma ray curves value adjustable from 0.1-9.9, logarithmic dimming and linear dimming optional

## SPECIFICATIONS

• Input Voltage	12-24VDC	• Remarks	Constant voltage
• Output Current	5x8A	• Protection	Short Circuit
• Output Power	5x(96-192)W	• Dimensions	6.5" x 2.9" x 1.5"

## ORDERING GUIDE

Model	Description
LB2108A-M5-3-100	DMX512 & RDM DECODE

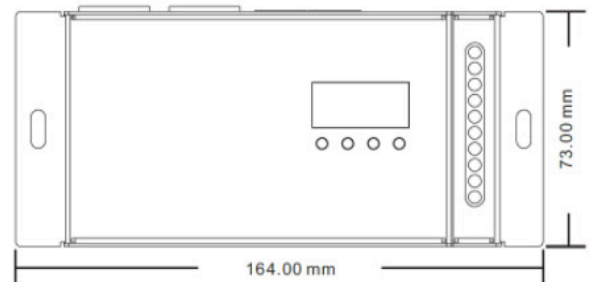
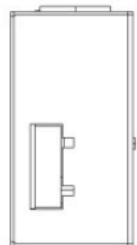
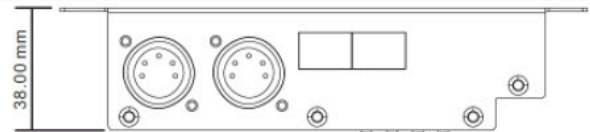

**Important:** Read All Instructions Prior to Installation

**Function introduction**

3/5 Pin male & female XLR terminal: DMX512 signal input & output  
2xRJ45 terminal: DMX512 signal input & output

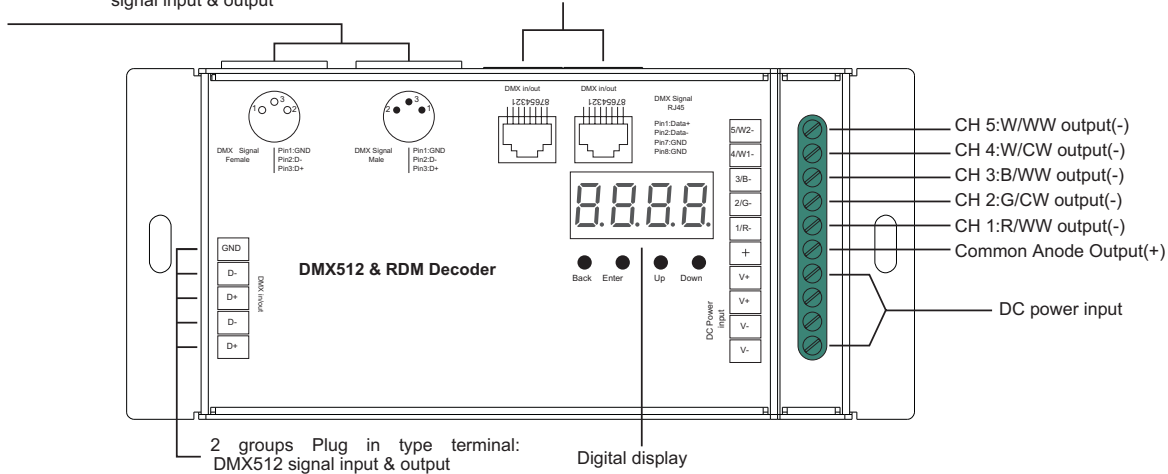

**Product Data**

Input Voltage	Output Current	Output Power	Remarks	Size(LxWxH)	Protection
12-24VDC	5x8A	5x(96-192)W	Constant voltage	164x73x38mm	Short circuit

- DMX512 RDM decoder, RDM function can realize intercommunication between DMX master and decoder. for example, you can set DMX decoder's address by DMX master console.
- Metal housing, digital display to show data directly, easily to set and show DMX address.
- With multiple kinds of DMX in/out ports: RJ 45, XLR , normal screws.
- Total 5 PWM output channels, common anode. DMX channel quantity from 1CH-5CH settable
- PWM output resolution ratio 8bit , 16bit settable.
- Output PWM frequency from 500HZ ~ 30K HZ settable.
- Output dimming curve gamma value from 0.1 ~ 9.9 settable.
- Decoding mode settable.
- Galvanic isolation

**Safety & Warnings**

- DO NOT install with power applied to device.
- DO NOT expose the device to moisture.

**Operation**

**Button introduction**

Up, Down button is for menu selection. After power on the decoder, if keep on clicking Up button, you will find below menu on display:

DMX signal indicator ● :: When DMX signal input is detected, the indicator on the display following after 8 turns on red 8.XXX

- 8.XXX Means DMX address. factory defaults setting is 001.
- 88XX Means DMX channels quantity. factory defaults setting is Ch05
- 88XX Means Bit (8bit or 16bit). factory defaults setting is 16bit
- 88XX Means output PWM frequency. factory defaults setting is 1K HZ
- 88XX Means output dimming curve gamma value, factory defaults setting is ga 1.5
- 88XX Means Decoding mode, factory defaults setting is dp1.1

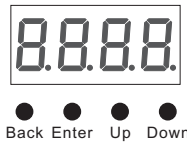

## Wiring diagram

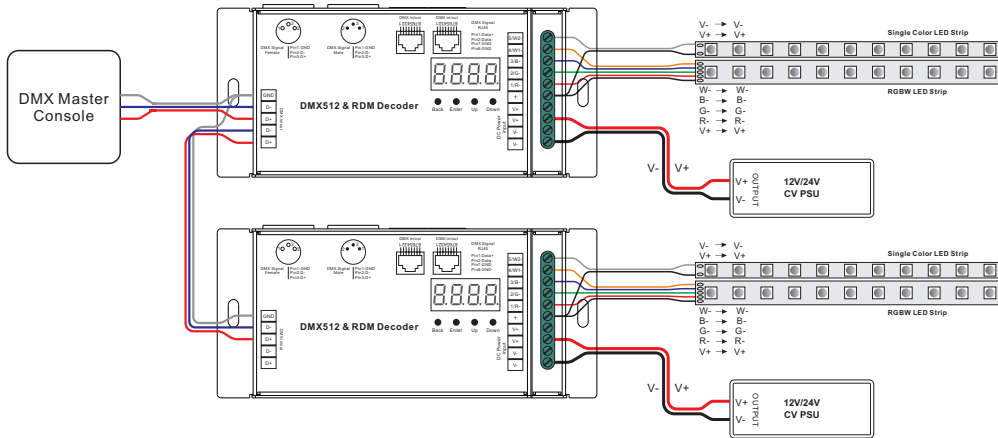

By holding button Back + Enter together at the same time over 5 seconds until the display go off, it will restore default settings .

### 1. DMX address setting:

select menu **8 XXX** , click button "Enter", display flashes, then click or hold button "Up" / "Down" to set DMX address (click is slow, hold is fast.), then click button "Back" to confirm.

### 2. DMX channel quantity setting:

Select menu **88 XX**, click button "Enter", display flashes, then click button "Up" / "Down" to set DMX channel quantity , then click button "Back" to confirm.

For example the DMX address is already set 001.

CH01=1 DMX address for all the output channels, which are all address 001.

CH02=2 DMX addresses , output 1&3 is address 001, output 2,4&5 is address 002

CH03=3 DMX addresses, output 1, 2 is address 001,002, output 3,4&5 is address 003

CH04=4 DMX addresses, output 1,2,3 is address 001,002,003, output 4&5 is address 004

CH05=5 DMX addresses, output 1,2,3,4,5 is address 001,002,003,004,005.

### 3. PWM output resolution Bit setting:

select menu **88 XX**, click button "Enter", display flashes, then click button "Up" / "Down" to choose 08 or 16 bit, then click button "Back" to confirm.

### 4. output PWM frequency setting:

select menu **88 XX**, click button "Enter", display flashes, then click button "Up" / "Down" to choose 00~30, then click button "Back" to confirm. 00=500HZ, 01=1kHz, 02=2kHz.....30=30kHz.

### 5. output dimming curve gamma value setting:

select menu **88 XX**, click button "Enter", display flashes, then click or hold button "Up" / "Down" to choose 0.1~9.9, then click button "Back" to confirm.

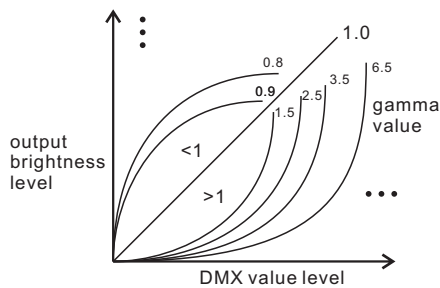

### 6. DMX decoding mode setting:

Select menu **88 XX** , click button "Enter", display flashes, then click or hold button "Up" / "Down" to choose the decoding mode, then click button "Back" to confirm. "dPxx" means the DMX address quantity used for control of corresponding PWM output channel quantity. 1st "x" is DMX address quantity, 2nd "x" is PWM channel quantity.

Micro dimming: the micro dimming effect can only be visible when the dimming curve gamma value is set lower than 1.4, and the lower the value is, the more visible the micro dimming effect will be.

PREPARED BY:  
PROJECT:  
TYPE:



# ULTRA-PRO 5 CHANNEL DMX512 & RDM DECODER CONTROLLER SERIES

### DMX address is 001, CH01

DMX Console Slider number / DMX channel	dp1.1	dp2.1
1	for all output dimming	for all output dimming
2	No use	for all output micro dimming

### DMX address is 001, CH02

DMX Console Slider number / DMX channel	dp1.1	dp2.1	dp3.2
1	for output 1&3 dimming	for output 1&3 dimming	for output 1&3 dimming
2	for output 2,4 &5 dimming	for output 1&3 micro dimming	for output 2,4 &5 dimming
3		for output 2,4 &5 dimming	for all output dimming
4		for output 2,4&5 micro dimming	

### DMX address is 001, CH03

DMX Console Slider number / DMX channel	dp1.1	dp2.1	dp4.3	dp5.3
1	for output 1 dimming	for output 1 dimming	for output 1 dimming	for output 1 dimming
2	for output 2 dimming	for output 1 micro dimming	for output 2 dimming	for output 2 dimming
3	for output 3,4 &5 dimming	for output 2 dimming	for output 3,4&5 dimming	for output 3,4&5 dimming
4		for output 2 micro dimming	for all output master dimming	for all output master dimming
5		for output 3,4 &5 dimming		strobe effects
6		for output 3,4&5 micro dimming		

### DMX address is 001, CH04

DMX Console Slider number / DMX channel	dp1.1	dp2.1	dp5.4	dp6.4
1	for output 1 dimming	for output 1 dimming	for output 1 dimming	for output 1 dimming
2	for output 2 dimming	for output 1 micro dimming	for output 2 dimming	for output 2 dimming
3	for output 3 dimming	for output 2 dimming	for output 3 dimming	for output 3 dimming
4	for output 4&5 dimming	for output 2 micro dimming	for output 4&5 dimming	for output 4&5 dimming
5		for output 3 dimming	for all output master dimming	for all output master dimming
6		for output 3 micro dimming		strobe effects
7		for output 4 &5 dimming		
8		for output 4&5 micro dimming		

### DMX address is 001, CH05

DMX Console Slider number / DMX channel	dp1.1	dp2.1	dp6.5	dp7.5
1	for output 1 dimming	for output 1 dimming	for output 1 dimming	for output 1 dimming
2	for output 2 dimming	for output 1 micro dimming	for output 2 dimming	for output 2 dimming
3	for output 3 dimming	for output 2 dimming	for output 3 dimming	for output 3 dimming

PREPARED BY:  
PROJECT:  
TYPE:



# ULTRA-PRO 5 CHANNEL DMX512 & RDM DECODER CONTROLLER SERIES

4	for output 4 dimming	for output 2 micro dimming	for output 4 dimming	for output 4 dimming
5	for output 5 dimming	for output 3 dimming	for output 5 dimming	for output 5 dimming
6		for output 3 micro dimming	for all output master dimming	for all output master dimming
7		for output 4 dimming		strobe effects
8		for output 4 micro dimming		
9		for output 5 dimming		
10		for output 5 micro dimming		

### Short circuit protection

If short circuit of the connected load is detected, the display will flash to alarm and the load will be forced to open circuit status. Once the fault is removed, the decoder will recover after re-powered on.

### The data definitions for strobe channel are as follows:

```
{0, 7},//undefined
{8, 65},//slow strobe-->fast strobe
{66, 71},//undefined
{72, 127},//slow push fast close
{128, 133},//undefined
{134, 189},//slow close fast push
{190, 195},//undefined
{196, 250},//random strobe
{251, 255},//undefined
```

### The supported RDM PIDs are as follows:

```
DISC_UNIQUE_BRANCH
DISC_MUTE
DISC_UN_MUTE
DEVICE_INFO
DMX_START_ADDRESS
IDENTIFY_DEVICE
SOFTWARE_VERSION_LABEL
DMX_PERSONALITY
DMX_PERSONALITY_DESCRIPTION
SLOT_INFO
SLOT_DESCRIPTION
MANUFACTURER_LABEL
SUPPORTED_PARAMETERS
```

### Restore to Factory Default Setting

Press and hold down both "Back" and "Enter" keys until the digital display turns off, then release the keys, system will reset and the digital display will turn on again, all settings will be restored to factory default.

Default settings are as follows:

```
DMX Address Code: a001
DMX Address Quantity: SW1=0: ch05, SW1=1: ch04
PWM Resolution Mode: bt16
PWM Frequency: pf01
Gamma: ga1.5
Decoding Mode: dp1.1
```

### Product Dimension

