



# 200W 5 IN 1 POWER SUPPLIES

PROJECT:  
PREPARED BY:  
DATE:  
TYPE:



## FEATURE

- Output constant voltage
- Built-in PFC function
- Protections: short circuit/ over voltage/ over heat
- Cooling by free air convection
- Flicker-free
- Work with leading edge & trailing edge triac dimmers
- Class 2, Class P, Type HL, CE, UL, FCC compliant
- PWM output, does not change the color index
- Metal housing
- Suitable for dry location & wet location
- Strong compatibility, flicker-free dimming
- Suitable for LED lighting and moving sign applications
- Compliance to worldwide safety regulations for lightings.
- Compatible with Forward phase, Reverse phase, Triac, MLV, ELV Dimmers
- 5 years warranty

## PERFORMANCE

• Wattage	200W	• Environment	IP67
• Input Voltage	AC 110-277V	• Minimum Load	30%
• PF	>0.96	• Weight	2.97 lb
• Efficiency	≥92%	• Dimensions	L 8" x W 4.6" x H 1.68"
• Dimming Range	0-100%		

## ORDERING GUIDE

Model	Dimming	Output Voltage	Wattage	Load Regulation
LB55501	Triac / 0-10V	24V	200W	3±

**DIMENSION**

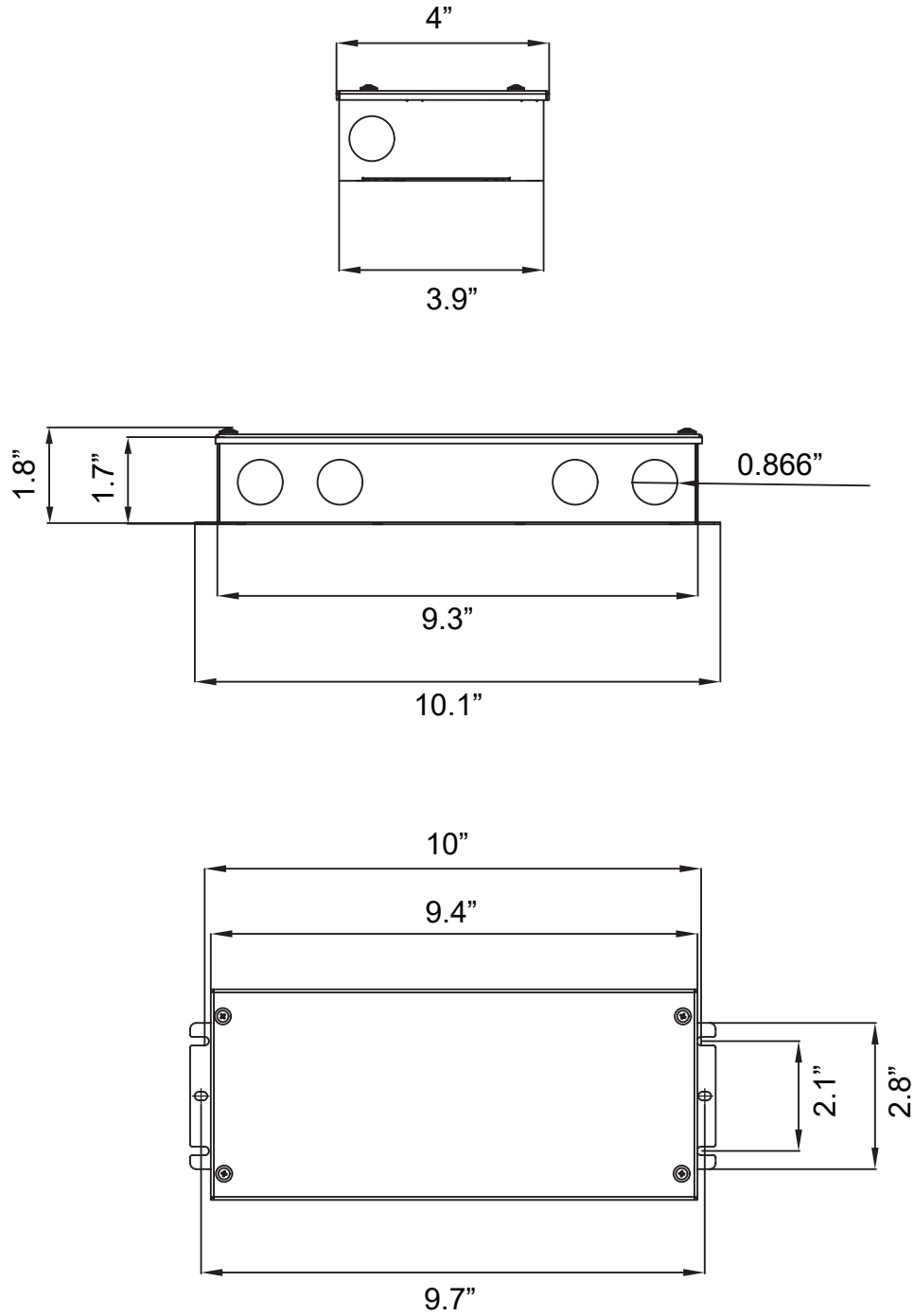



**200W 5 IN 1**  
POWER SUPPLIES

PROJECT:  
PREPARED BY:  
DATE:  
TYPE:

**SPECIFICATION CHART**

Output	Voltage	24V
	Voltage Tolerance	±3%
	Voltage Regulation	≤0.5%
	Load Regulation	≤1%
	Rated Current	8.33A
	Rate Power	200W
	Voltage Ripple	250mVp-p
	Overshoot Voltage	<20% full load
	Output Voltage Adjustment	24-26V
Input	Voltage Range	110-277V
	Frequency Range	47-63Hz
	Power Factor (Typ.)	>0.96@277VAC
	THD (Typ.)	<15%@277VAC
	Full Load Efficiency (Typ.)	≥92%@277VAC
	AC Current (Max.)	≤0.91A@277VAC
	Standby Power	≤0.5W
	Inrush Current (Typ.)	96.7A@50%I <sub>peak</sub> 192us @277VAC
	Leakage Current	<0.5mA
Protection	Short Circuit	Hiccup mode, can be automatically restored after abnormal removal
	Over Load	≥120%, Constant - Current Mode, automatic recovery after exception
	Over Temperature	When the ambient temperature exceeds 55°C ±5°C, the output is turn off
Environment	Working Temperature	-40°C to 40°C
	Working Humidity	20-95%RH Non-condensing
	Storage Temperature	-40°C to 80°C, 10-95%RH Non-condensing
	Temperature coefficient	±0.03%°C (0-50%°C)
	Vibration	10-500Hz, 5G 12 minutes/cycles, X Y Z axis 72 minute each

**DIMMING AND CONNECTING DIAGRAM**

**Triac & 0/1-10V**

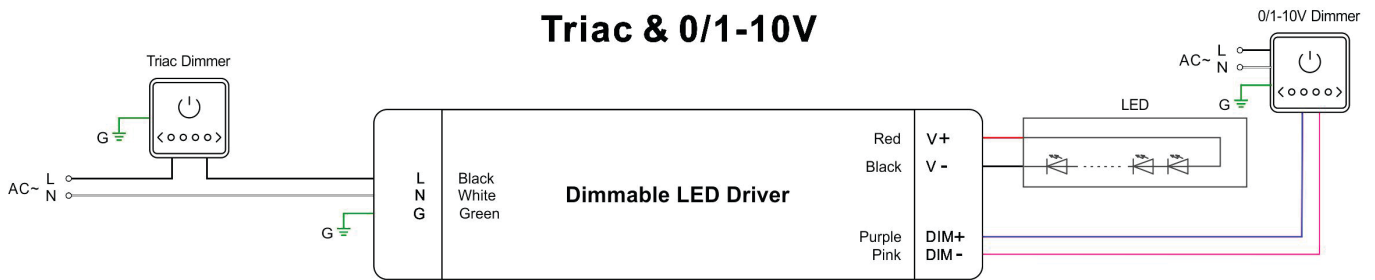

Using two ways of dimming at the same time you must be assured that LED lighting is up to the max. Brightness then you could operate with the other dimming

**Triac**

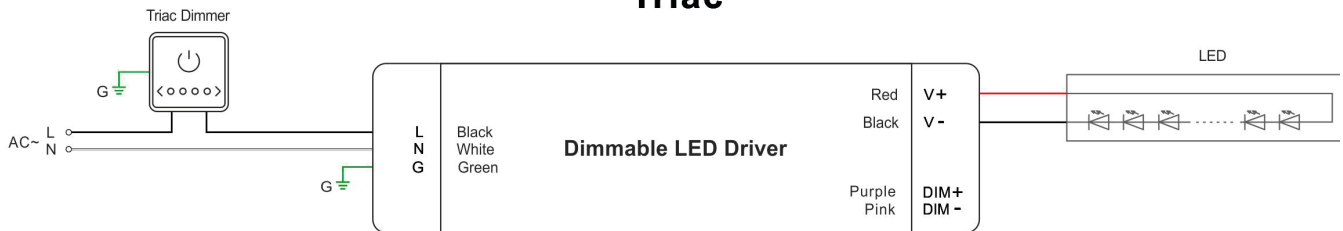

Using one dimming ---TRIAC/Phase cut dimming

1. The Pulse-Width Modulation (PWM) of output voltage can be adjusted through input terminal of the AC phase line(L) by connection a phase /Triac dimmer or lighting system.
2. Working with forward phase /leading edge, MLV and Reverse phase /trailing edge, ELV, TRIAC dimmers or light system.
3. Min. loading is about 30%
4. Please try to use dimmers with power at least 1.5 times as the output power of the driver.

### 0/1-10V

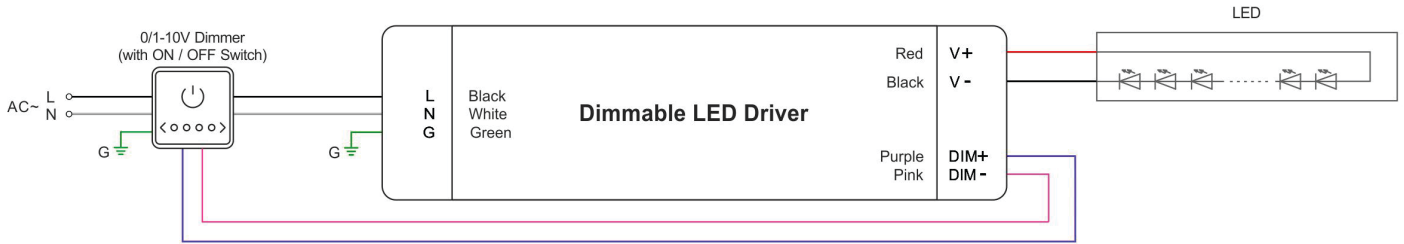

### 0-10V / 10V PWM

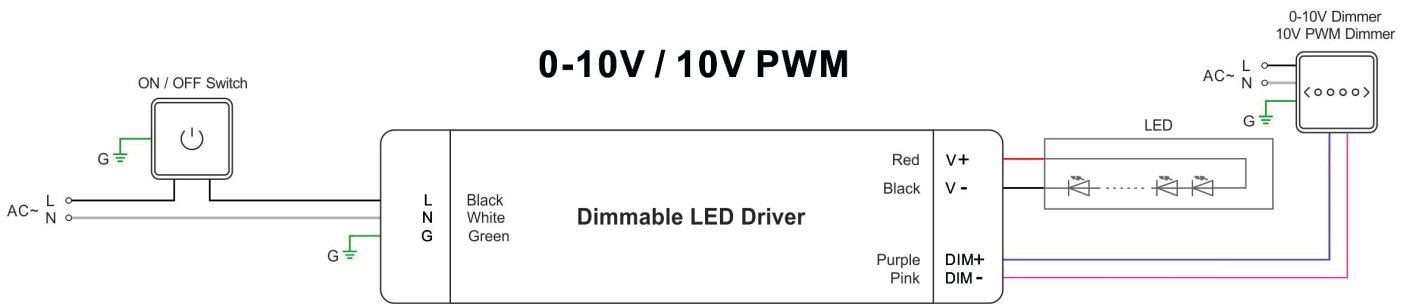

### 1-10V / Potentiometer

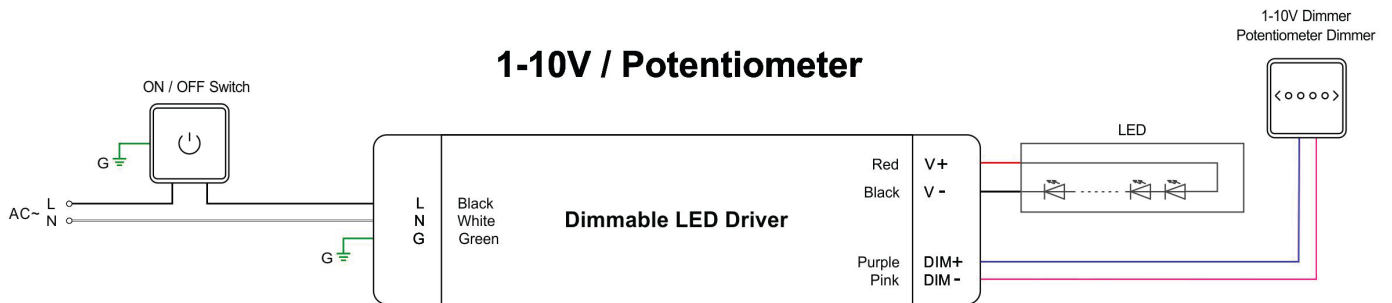

Using one dimming ---0-10/ 1-10V/ 10V PWM/ Potentiometer dimming

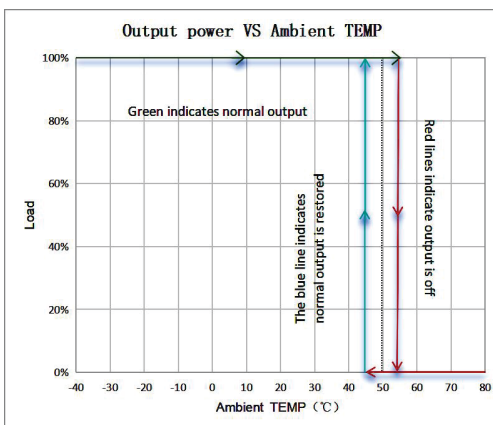

#### Derating Curve (output load vs TEMP.)

1. To extend their life, please refer to the Derating Curve and derate according to the temperature.
2. The output current of the LED driver should be selected according to the rated current of the lamp and the ambient temperature.  
Normally, we recommend the power supply to reserve a certain amount of load to extend LED driver's life.

# 200W 5 IN 1

POWER SUPPLIES

PROJECT:

PREPARED BY:

DATE:

TYPE:

## POWER FACTOR CURVE

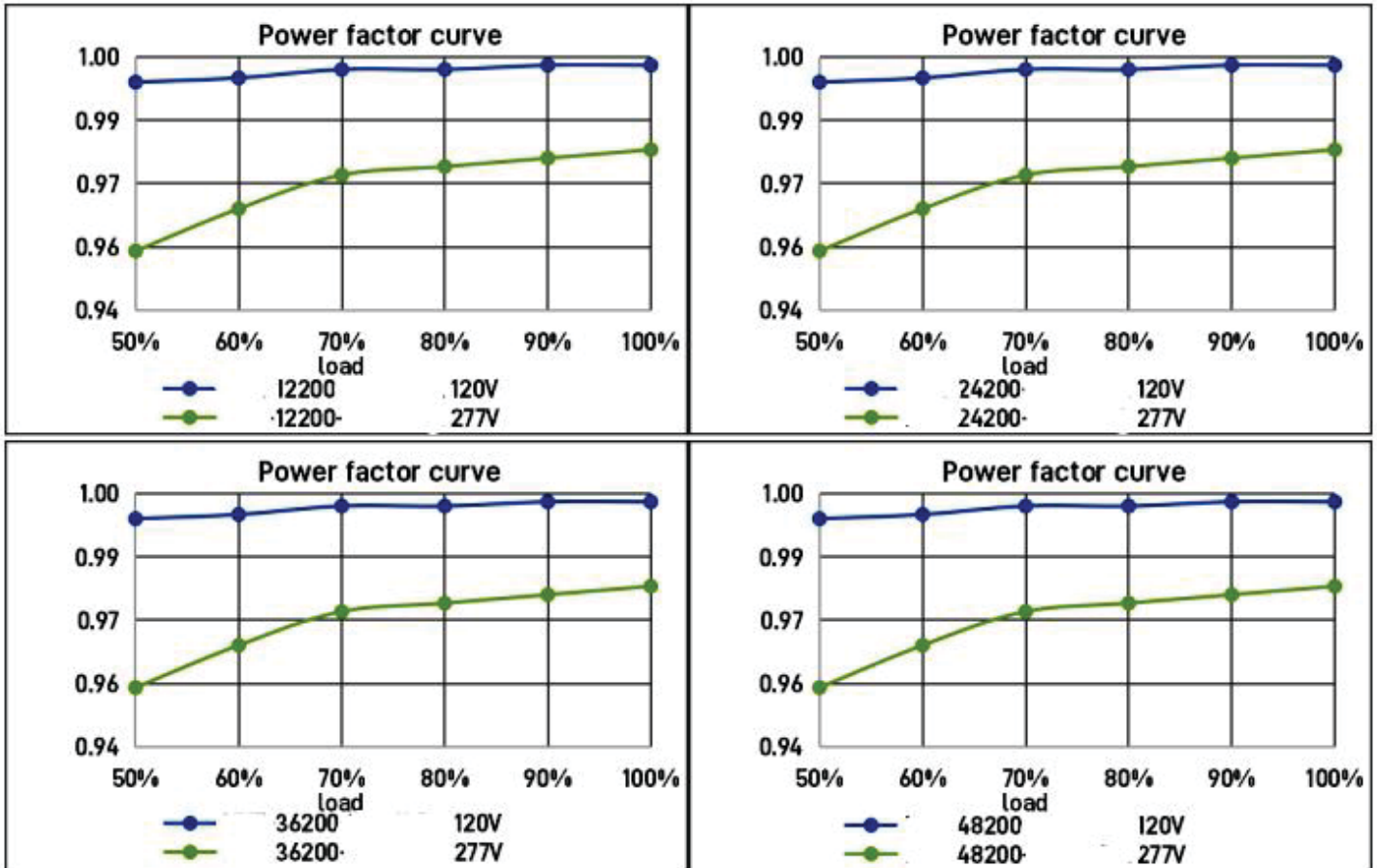

# 200W 5 IN 1

POWER SUPPLIES

PROJECT:

PREPARED BY:

DATE:

TYPE:

## EFFICIENCY CURVE

