



LED Flood Light

PROJECT:
PREPARED BY:
DATE:
TYPE:



PERFORMANCE

• Wattage	35W/15W	• Input Voltage	120-277V
• CCT	3000K / 3500K / 5000K	• Dimming	0-10V
• Lumens	140LM/W	• Frequency	50/60Hz
• PF	>0.9	• Warranty	5 Years

ORDERING GUIDE

Model	Wattage	CCT	Lumens
LB10211	35W/15W	3000K / 3500K / 4000K	140LM/W



LED Flood Light

PROJECT:
PREPARED BY:
DATE:
TYPE:

DIMENSION

35W/15W

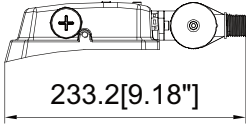
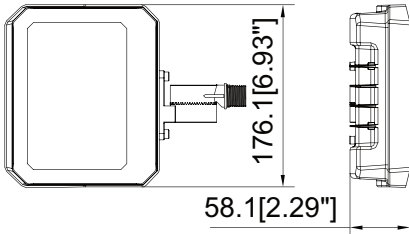

Knuckle

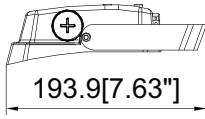
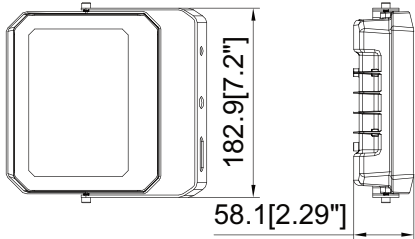

Yoke

LED Flood Light

PROJECT:

PREPARED BY:

DATE:

TYPE:

INSTALLATION

1. Use a screwdriver to remove the fixing screws, as shown in Figure 1.

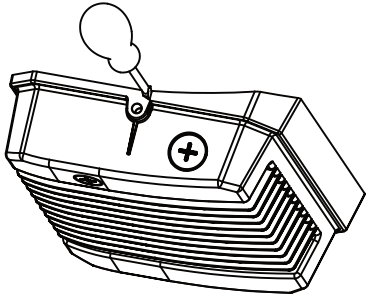

2. Remove the fixing screws and cover plate, as shown in Figure 2.

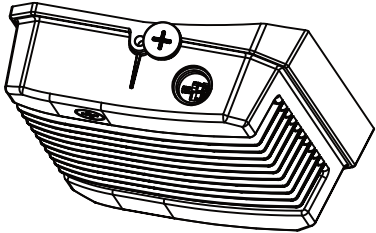

3. Flip the color temperature switch to the desired color temperature, flip the power switch to the desired wattage, as shown in Figure 3.

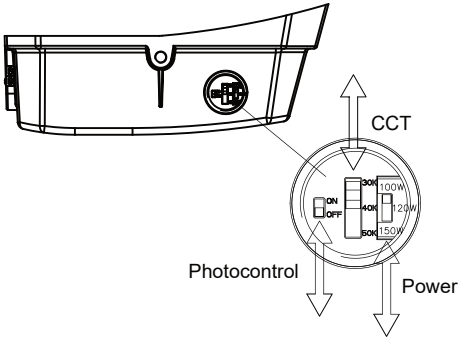

4. Restore the installation in the order of Step 321, as shown in Figure 4.

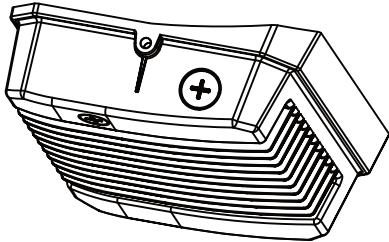

LED Flood Light

PROJECT:

PREPARED BY:

DATE:

TYPE:

APPLICATION



Safety Information

- 1、 Using the standard working voltage: AC120~277V & AC120-347V , 50/60Hz, do not exceed.
- 2、 Be sure the power supply is turned off before installation.
- 3、 Switch off power of the mains supply or the connection lead respectively before doing any works.
- 4、 Please note waterproof, dustproof, electricity prevention and shockproof for the external power wires.
- 5、 Directly bolts on the installation stem through the hole on the mounting bracket.
- 6、 Be sure the connection between the wires is in good condition when install the lamps, beware of leakage.
- 7、 Please read the specification carefully before installation.
- 8、 The complete installation must be handled by an electrical expert.